

# MINOR FLAWS

specifications & instructions

stoft

Design studio

+46 (0)703 79 86 60  
info@stoft-studio.com  
www.stoft-studio.com

Nobelvägen No. 90  
212 15 Malmö - SWEDEN

# MINOR FLAWS

product specifications

**Material** / Tinted glass and brass

**Production** / Mouth blown in Sweden by Micke Johansson and Bergdala Glass works

**Design** / Stoff Studio

**Light source included** / Dimmable E27 Clear LED bulb, 7W, 2700K, 806lm

**Rated Watts** / Max 25 Watt

**Rated Voltage** / 220-240V 50/60hz

**IP-Class** / IP20

**Cable included** / 230 cm textile, colour linen

**Canopy included** / No

**Approximate weight** / 2,5 - 4 kg

**Approximate dimensions** / Ø 22 - 26 cm, height 30 - 42 cm

**Size of box** / 57 x 38 x 38 cm

**Model** / The lamp is available in 4 different models:

## MODEL OVERVIEW

approximate dimensions

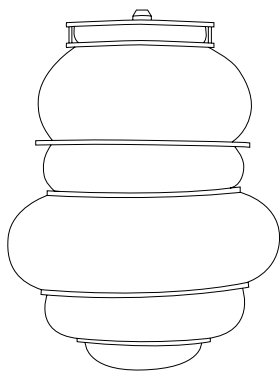

**ACORN**  
Ø 24 cm,  
Height 36 cm

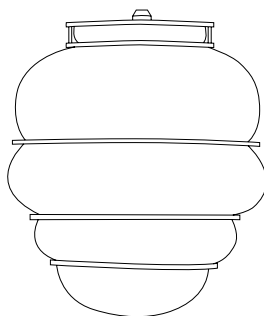

**CHESTNUT**  
Ø 24 cm,  
Height 31 cm

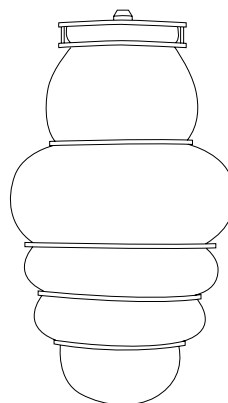

**FIRCONE**  
Ø 22 cm,  
Height 40 cm

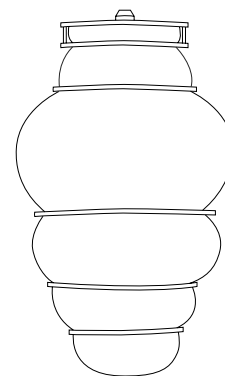

**PINECONE**  
Ø 22 cm,  
Height 35 cm

# WIRE AND CABLE ATTACHMENT

installation

1. Fasten the attachment to the ceiling with suitable screw and dowel  
(Refer to attachment on page 4)

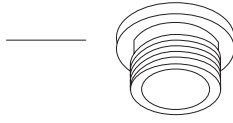

2. Thread the wire through the attachment cap before screwing it on to the attachment (1)

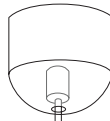
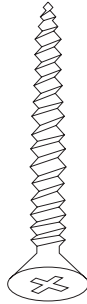

3. Insert the wire into the gripper and adjust the height  
(Refer to Gripper on page 4)

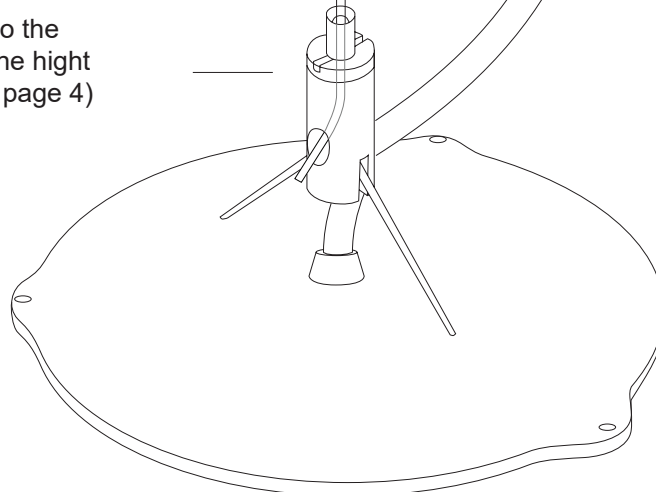

4. Connect the cable to the mains power supply: 220-240V, 50/60Hz whilst following local regulations

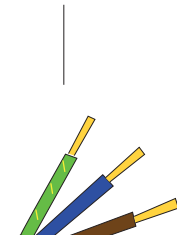

# GRIPPER

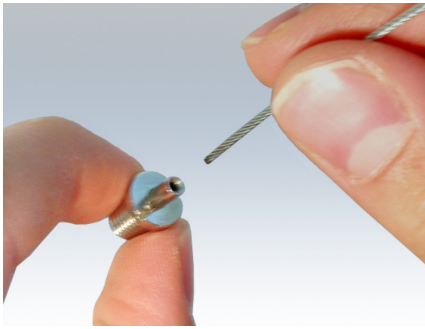

A. Insert wire into gripper

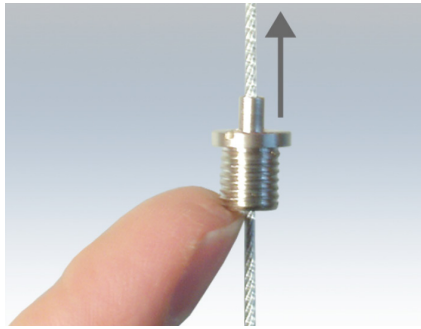

B. Adjust up

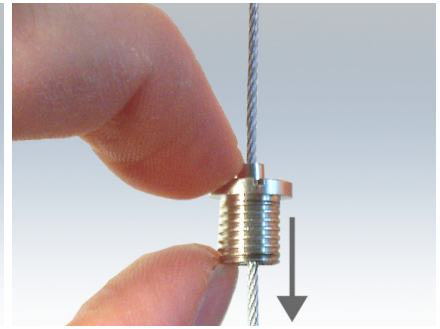

C. Press pin and adjust

1. The direction of the wire and gripper must be in a straight line
2. For safe installation the wire must be inserted all the way through the gripper and protrude at least 5 mm from the bottom.

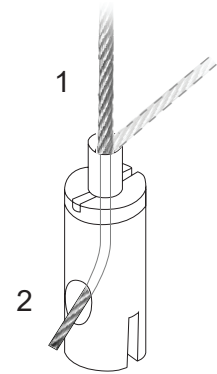

# ATTACHMENT

The attachment is used to fix the wire to the ceiling.

Ensure that you use suitable screws and dowels for the materials when installing it.



# CHANGING THE LIGHT BULB

*Note: Do not unscrew the screws without securing the glass cover.*

